

Silicon NPN Power Transistors

2SD1047

DESCRIPTION

- Complement to type 2SB817
- With TO-3PN package

APPLICATIONS

- Power amplification
- Low frequency and audio band

PINNING

PIN	DESCRIPTION
1	Base
2	Collector;connected to mounting base
3	Emitter

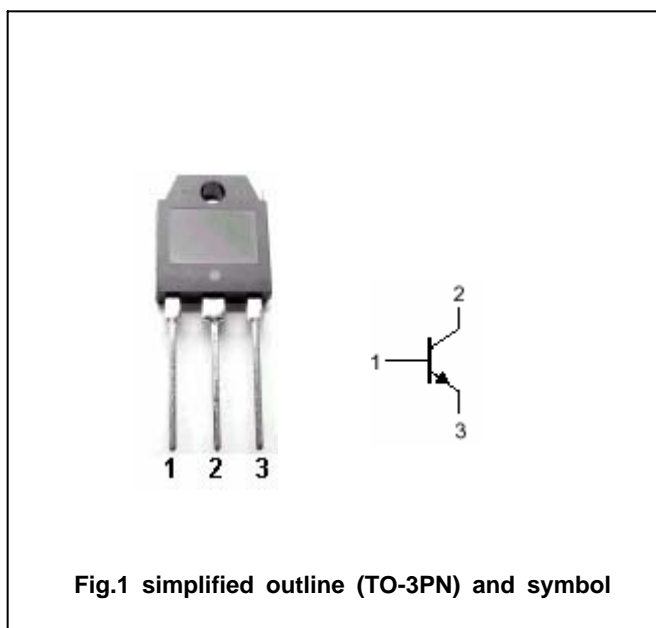
Absolute maximum ratings($T_a=25$)

SYMBOL	PARAMETER	CONDITIONS	VALUE	UNIT
V_{CBO}	Collector-base voltage	Open emitter	160	V
V_{CEO}	Collector-emitter voltage	Open base	140	V
V_{EBO}	Emitter-base voltage	Open collector	6	V
I_C	Collector current (DC)		12	A
I_{CM}	Collector current-peak		15	A
P_C	Collector power dissipation	$T_C=25$	100	W
T_j	Junction temperature		150	
T_{stg}	Storage temperature		-40~150	

Silicon NPN Power Transistors

2SD1047

CHARACTERISTICS

T_j=25 unless otherwise specified

SYMBOL	PARAMETER	CONDITIONS	MIN	TYP.	MAX	UNIT
V _{(BR)CEO}	Collector-emitter breakdown voltage	I _C =50mA ; I _B =0	140			V
V _{(BR)CBO}	Collector-base breakdown voltage	I _C =5mA ; I _E =0	160			V
V _{(BR)EBO}	Emitter-base breakdown voltage	I _E =5mA ; I _C =0	6			V
V _{CEsat}	Collector-emitter saturation voltage	I _C =5A ; I _B =0.5A			2.5	V
V _{BE}	Base-emitter on voltage	I _C =1A ; V _{CE} =5V			1.5	V
I _{CBO}	Collector cut-off current	V _{CB} =80V ; I _E =0			0.1	mA
I _{EBO}	Emitter cut-off current	V _{EB} =4V ; I _C =0			0.1	mA
h _{FE-1}	DC current gain	I _C =1A ; V _{CE} =5V	60		200	
h _{FE-2}	DC current gain	I _C =6A ; V _{CE} =5V	20			
f _T	Transition frequency	I _C =1A ; V _{CE} =5V		15		MHz
C _{OB}	Collector output capacitance	f=1MHz ; V _{CB} =10V		210		pF

Switching times

t _{on}	Turn-on time	I _C =1.0A ; I _{B1} =-I _{B2} =0.1A V _{CC} =20V , R _L =20		0.26		μs
t _s	Storage time			6.88		μs
t _f	Fall time			0.68		μs

◆ h_{FE-1} Classifications

D	E
60-120	100-200

Silicon NPN Power Transistors

2SD1047

PACKAGE OUTLINE

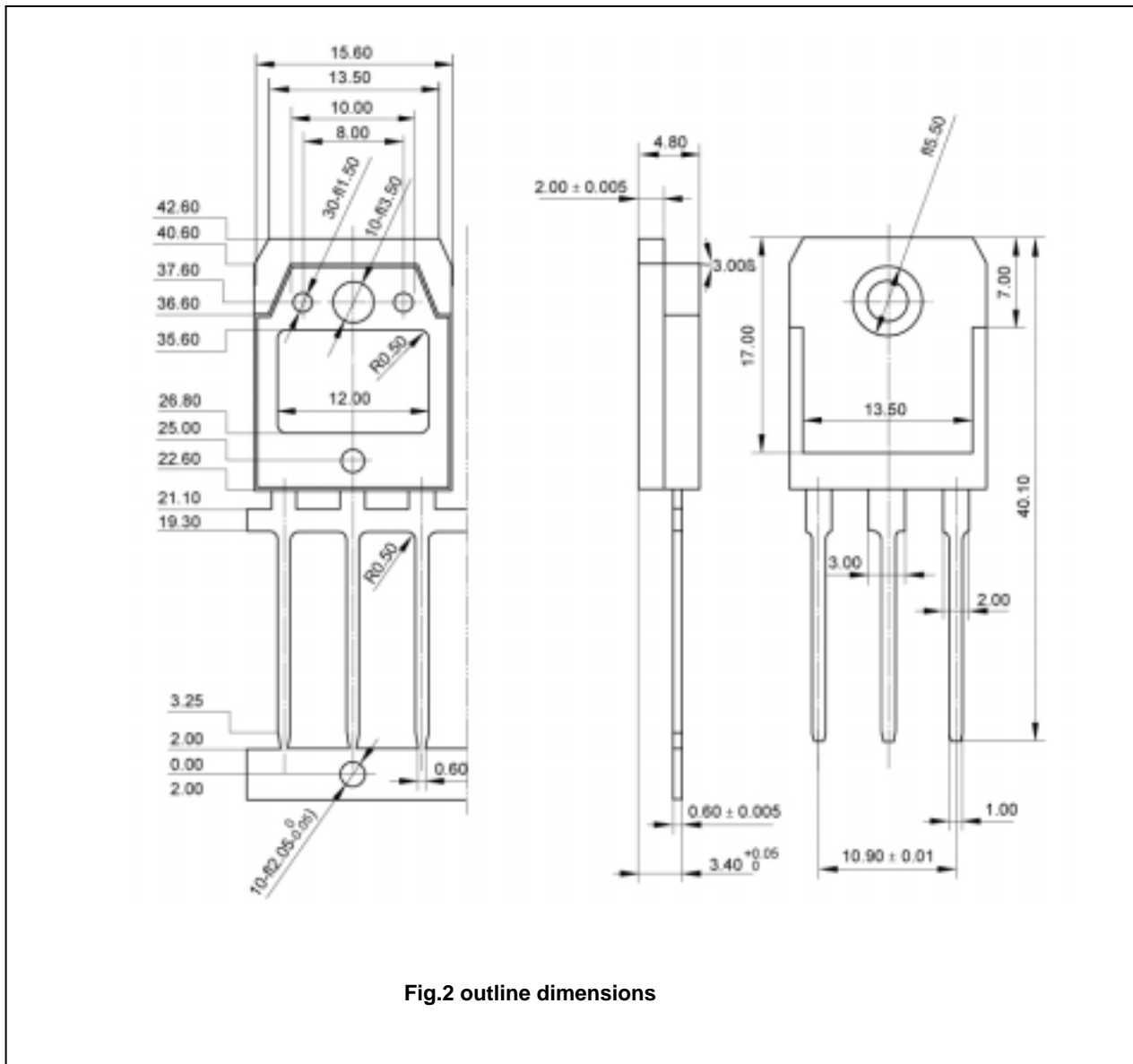

Fig.2 outline dimensions

Silicon Power Transistors

2SD1047

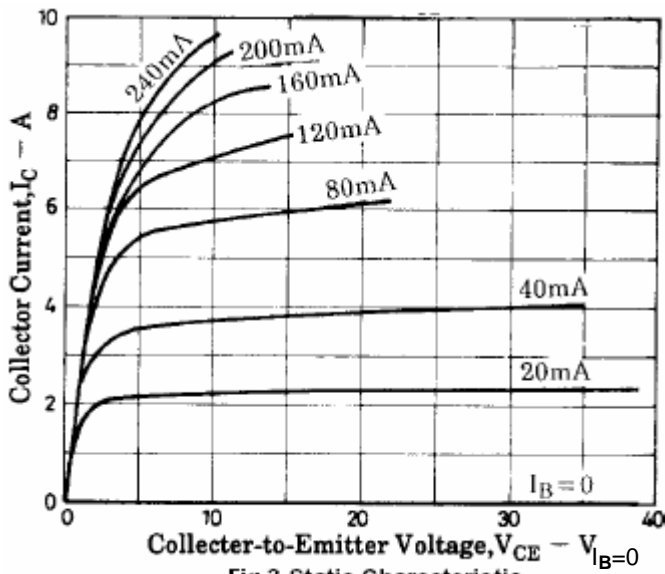

Fig.3 Static Characteristic

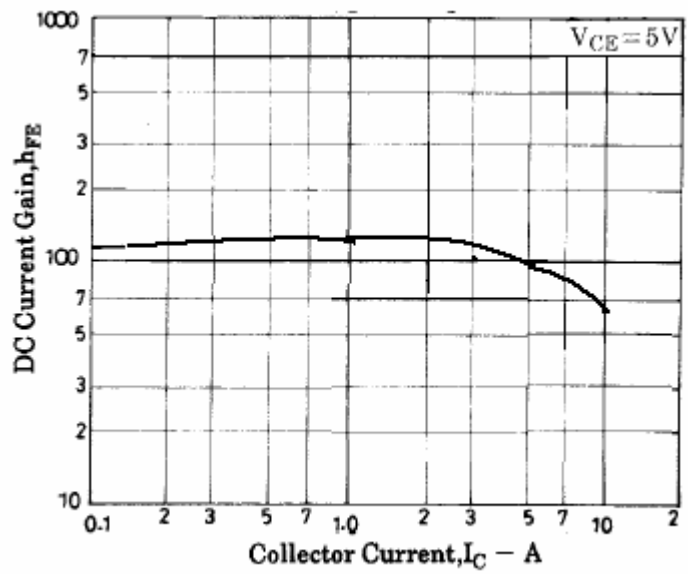

Fig.4 DC current Gain

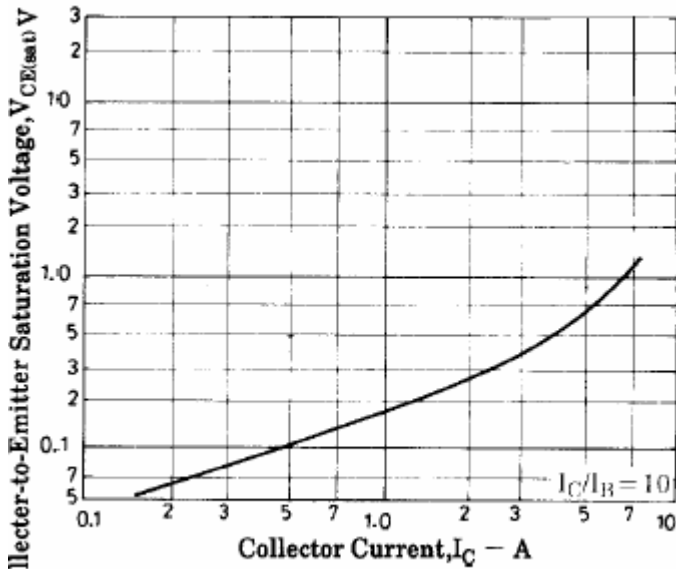

Fig.5 Collector-Emmitter Saturation Voltage

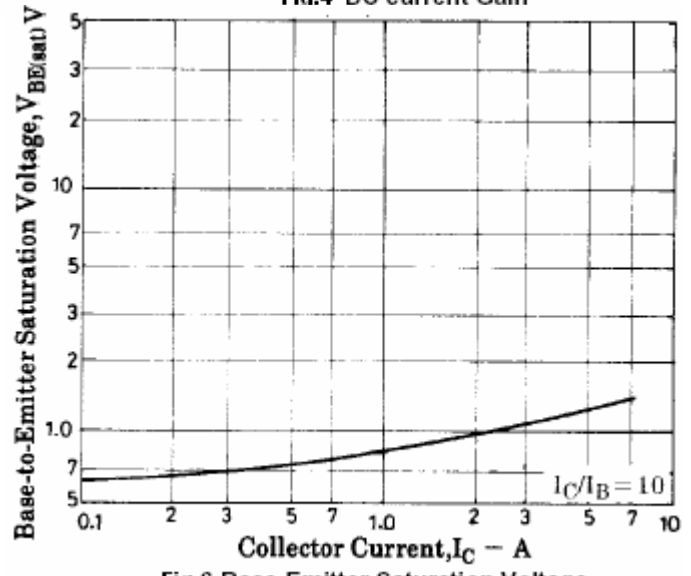

Fig.6 Base-Emmitter Saturation Voltage

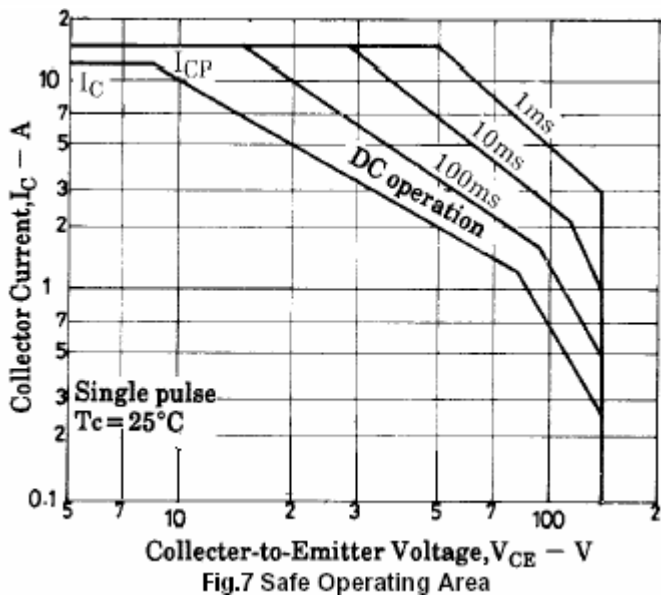

Fig.7 Safe Operating Area