

## 78M05 Three-terminal positive voltage regulator

### FEATURES

- Maximum output current  
 $I_{OM}$ : 0.5 A
- Output voltage  
 $V_O$ : 5V
- Continuous total dissipation  
 $P_D$ : 1.25 W

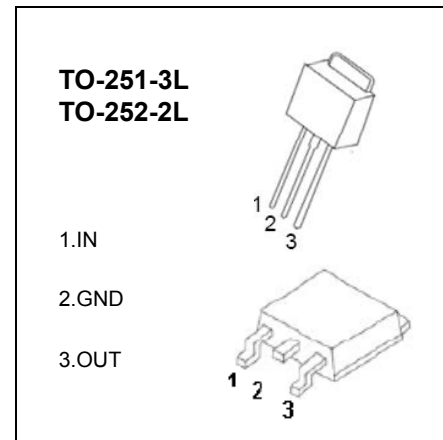

### ABSOLUTE MAXIMUM RATINGS (Operating temperature range applies unless otherwise specified)

Parameter	Symbol	Value	Unit
Input Voltage	$V_i$	25	V
Operating Junction Temperature Range	$T_{OPR}$	0-+125	°C
Storage Temperature Range	$T_{STG}$	-65-+150	°C

ELECTRICAL CHARACTERISTICS AT SPECIFIED VIRTUAL JUNCTION TEMPERATURE ( $V_i=10V, I_o=350mA, C_i=0.33\mu F, C_o=0.1\mu F$ , unless otherwise specified)

Parameter	Symbol	Test conditions	Min	Typ	Max	Unit
Output Voltage	$V_o$	$25^\circ C$	4.8	5	5.2	V
		$7V \leq V_i \leq 20V, I_o=5mA-350mA$ $P_o \leq 15W$	0-125°C	4.75	5	5.25
Load Regulation	$\Delta V_o$	$I_o=5mA-0.5A$	25°C	15	100	mV
		$I_o=5mA-200mA$	25°C	5	50	mV
Line Regulation	$\Delta V_o$	$7V \leq V_i \leq 25V, I_o=200mA$	25°C	3	100	mV
		$8V \leq V_i \leq 25V, I_o=200mA$	25°C	1	50	mV
Quiescent Current	$I_q$	25°C		4.2	6	mA
Quiescent Current Change	$\Delta I_q$	$8V \leq V_i \leq 25V, I_o=200mA$	0-125°C		0.8	mA
		$5mA \leq I_o \leq 350mA$	0-125°C		0.5	mA
Output Noise Voltage	$V_N$	10Hz ≤ f ≤ 100KHz	25°C	40	200	μV
Ripple Rejection	RR	$8V \leq V_i \leq 18V, f=120Hz, I_o=300mA$	0-125°C	62	80	dB
Dropout Voltage	$V_d$	$I_o=350mA$	25°C	2	2.5	V
Short Circuit Current	$I_{sc}$	$V_i=10V$	25°C	300		mA
Peak Current	$I_{pk}$		25°C	0.5		A

### TYPICAL APPLICATION

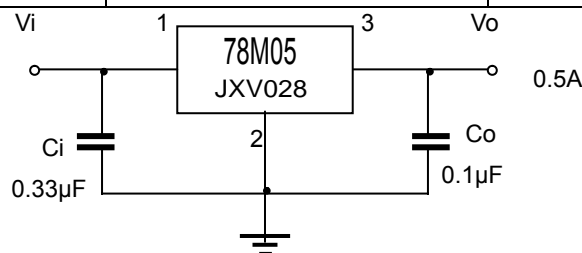

# Typical Characteristics

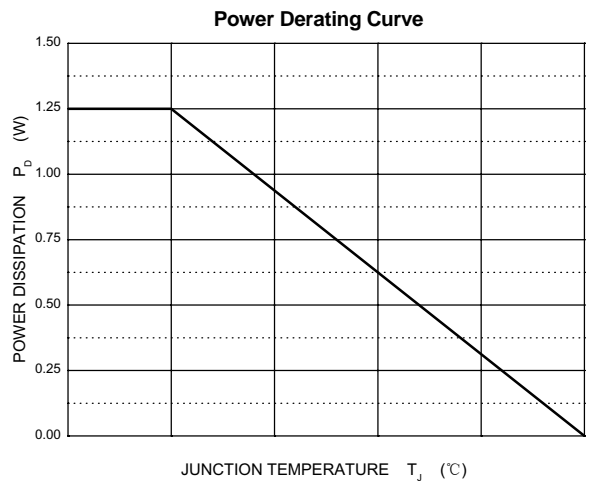
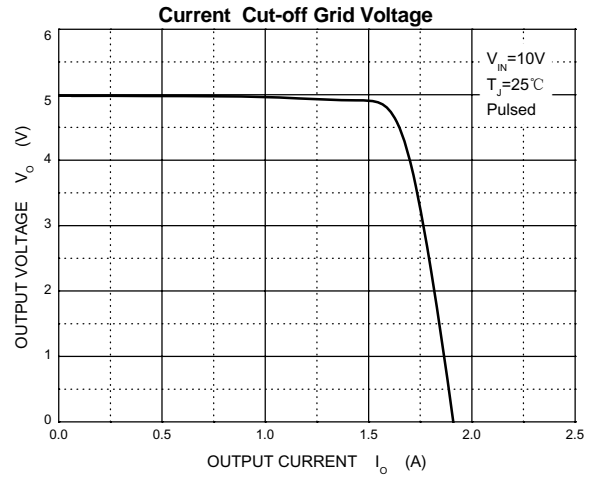
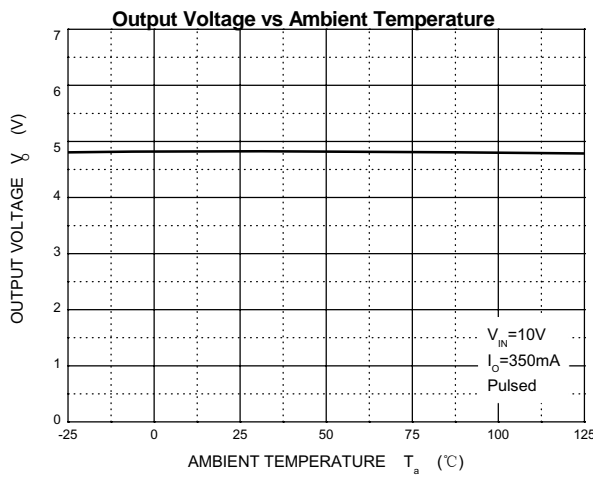
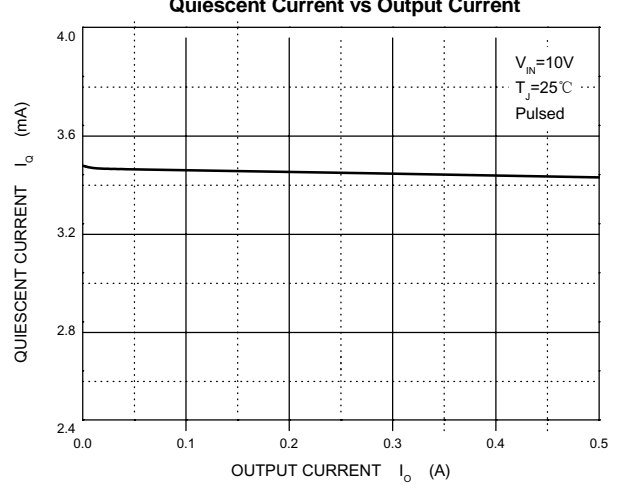
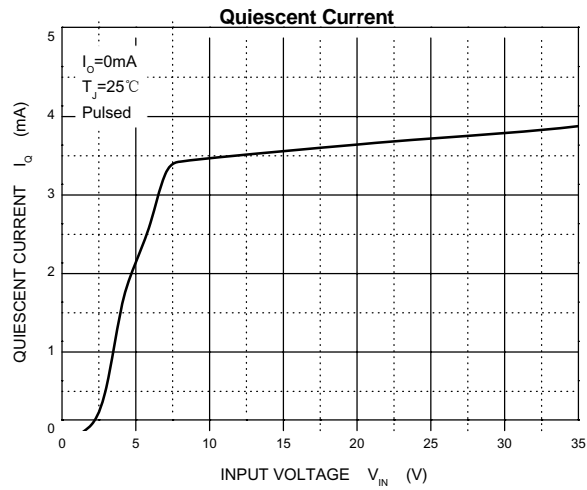
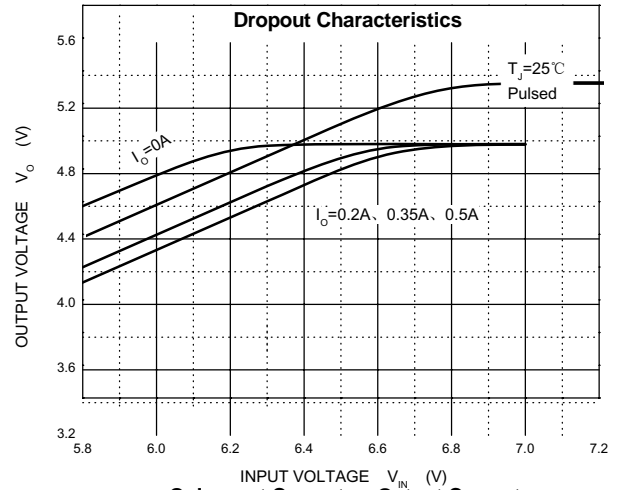
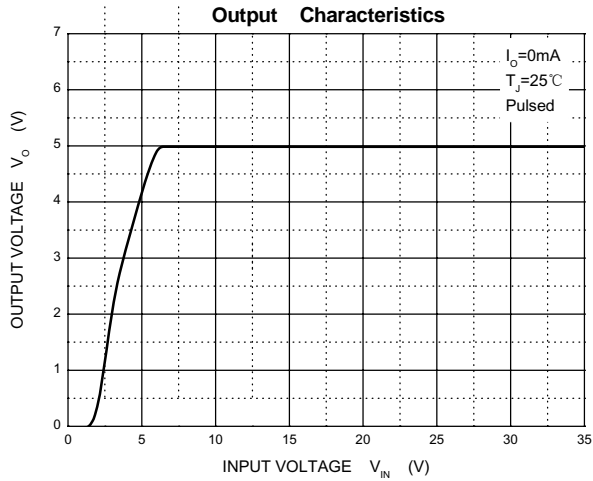

Shanghai Leiditech Electronic Co.,Ltd  
 Email: sale1@leiditech.com  
 Tel : +86- 021 50828806  
 Fax : +86- 021 50477059