

## TO-92 Plastic-Encapsulate Transistors

**SS8050** TRANSISTOR (NPN)

### FEATURES

- Power Dissipation  
 $P_{CM} : 1\text{ W}$  ( $T_a=25^\circ\text{C}$ )  
 $: 2\text{ W}$  ( $T_c=25^\circ\text{C}$ )

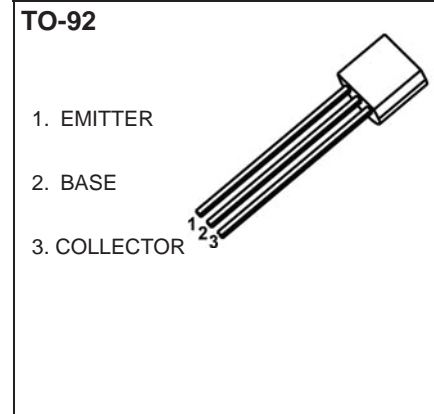

### MARKING

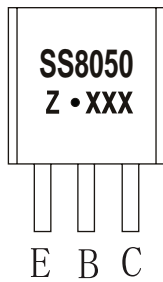

SS8050= Device code  
 Solid dot= Green molding compound device,  
 if none, the normal device  
 Z= Rank of  $h_{FE}$ ,  
 XXX= Code

### Equivalent Circuit

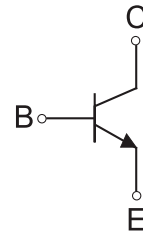

### ORDERING INFORMATION

| Part Number | Package | Packing Method | Pack Quantity |
|-------------|---------|----------------|---------------|
| SS8050      | TO-92   | Bulk           | 1000pcs/Bag   |
| SS8050-TA   | TO-92   | Tape           | 2000pcs/Box   |

### MAXIMUM RATINGS ( $T_a=25^\circ\text{C}$ unless otherwise noted)

| Symbol          | Parameter  | Value    | Unit                        |
|-----------------|--|----------|-----------------------------|
| $V_{CBO}$       | Collector-Base Voltage                           | 40       | V                           |
| $V_{CEO}$       | Collector-Emitter Voltage                        | 25       | V                           |
| $V_{EBO}$       | Emitter-Base Voltage                             | 5        | V                           |
| $I_c$           | Collector Current -Continuous                    | 1.5      | A                           |
| $P_D$           | Collector Power Dissipation                      | 625      | mW                          |
| $R_{\theta JA}$ | Thermal Resistance from Junction to Ambient      | 200      | $^\circ\text{C} / \text{W}$ |
| $T_J, T_{stg}$  | Operation Junction and Storage Temperature Range | -55~+150 | $^\circ\text{C}$            |



# SS8050

## ELECTRICAL CHARACTERISTICS ( $T_a=25^\circ\text{C}$ , unless otherwise specified)

| Parameter                            | Symbol        | Test conditions  | Min | Typ | Max | Unit          |
|--------------------------------------|---------------|--|-----|-----|-----|---------------|
| Collector-base breakdown voltage     | $V_{(BR)CBO}$ | $I_C=100\mu\text{A}$ , $I_E=0$                             | 40  |     |     | V             |
| Collector-emitter breakdown voltage  | $V_{(BR)CEO}$ | $I_C=0.1\text{mA}$ , $I_B=0$                               | 25  |     |     | V             |
| Emitter-base breakdown voltage       | $V_{(BR)EBO}$ | $I_E=100\mu\text{A}$ , $I_C=0$                             | 5   |     |     | V             |
| Collector cut-off current            | $I_{CBO}$     | $V_{CB}=40\text{V}$ , $I_E=0$                              |     |     | 0.1 | $\mu\text{A}$ |
| Emitter cut-off current              | $I_{CEO}$     | $V_{CE}=20\text{V}$ , $I_E=0$                              |     |     | 0.1 | $\mu\text{A}$ |
| Emitter cut-off current              | $I_{EBO}$     | $V_{EB}=5\text{V}$ , $I_C=0$                               |     |     | 0.1 | $\mu\text{A}$ |
| DC current gain                      | $h_{FE(1)}$   | $V_{CE}=1\text{V}$ , $I_C=100\text{mA}$                    | 85  |     | 400 |               |
|                                      | $h_{FE(2)}$   | $V_{CE}=1\text{V}$ , $I_C=800\text{mA}$                    | 40  |     |     |               |
| Collector-emitter saturation voltage | $V_{CE(sat)}$ | $I_C=800\text{mA}$ , $I_B=80\text{mA}$                     |     |     | 0.5 | V             |
| Base-emitter saturation voltage      | $V_{BE(sat)}$ | $I_C=800\text{mA}$ , $I_B=80\text{mA}$                     |     |     | 1.2 | V             |
| Base-emitter voltage                 | $V_{BE}$      | $V_{CE}=1\text{V}$ , $I_C=10\text{mA}$                     |     |     | 1   | V             |
| Transition frequency                 | $f_T$         | $V_{CE}=10\text{V}$ , $I_C=50\text{mA}$ , $f=30\text{MHz}$ | 100 |     |     | MHz           |

## CLASSIFICATION OF $h_{FE(1)}$

| Rank  | B      | C       | D       | D3      |
|-------|--------|---------|---------|---------|
| Range | 85-160 | 120-200 | 160-300 | 300-400 |



# SS8050

## Typical Characteristics

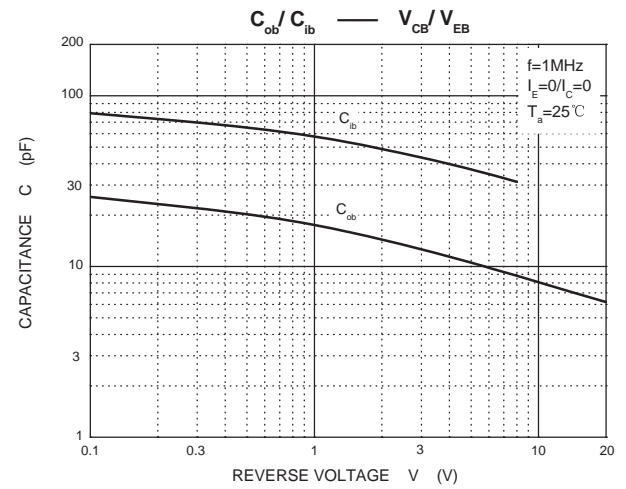
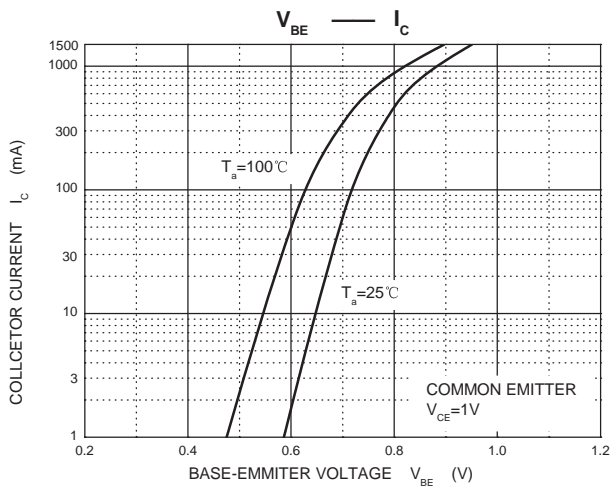
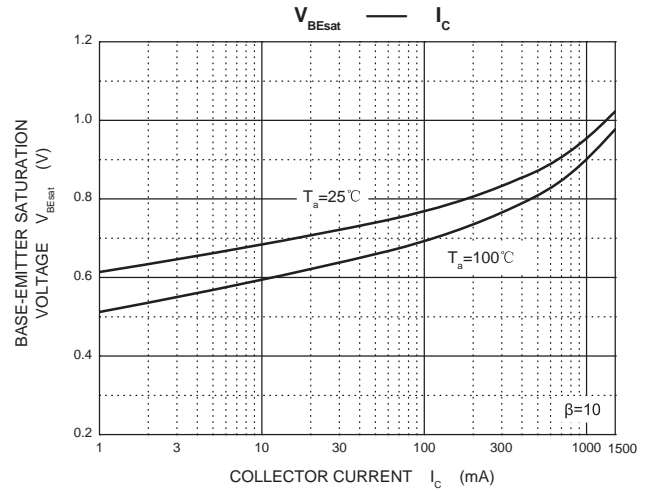
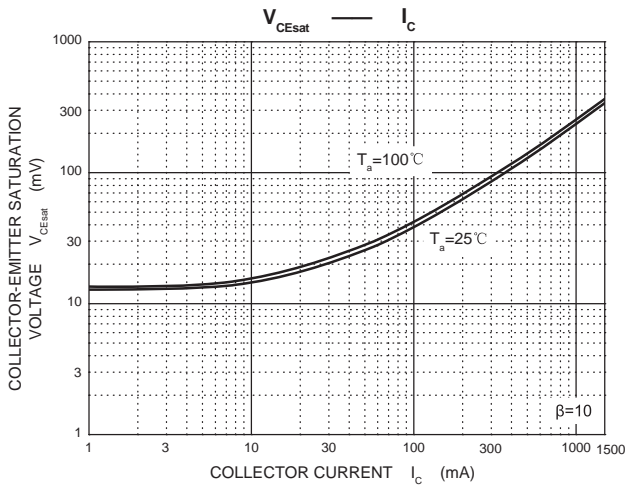
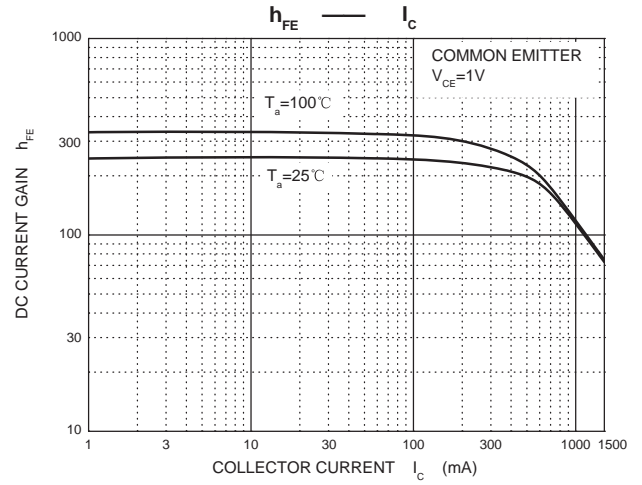
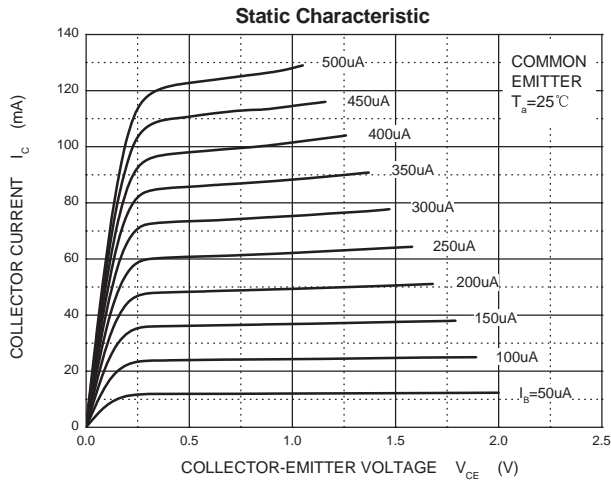



# SS8050

## Typical Characteristics(Con.)

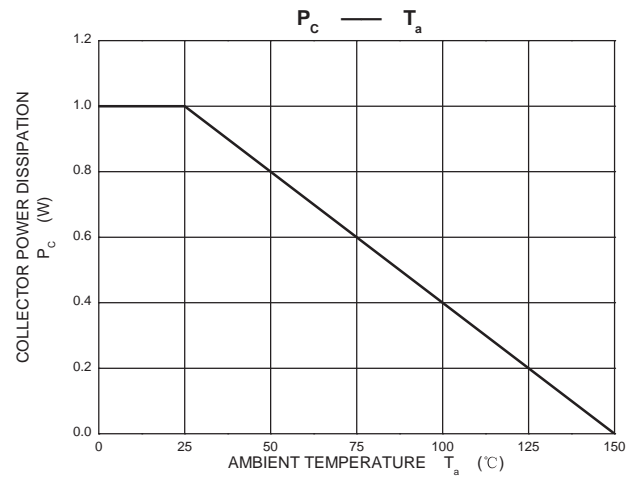
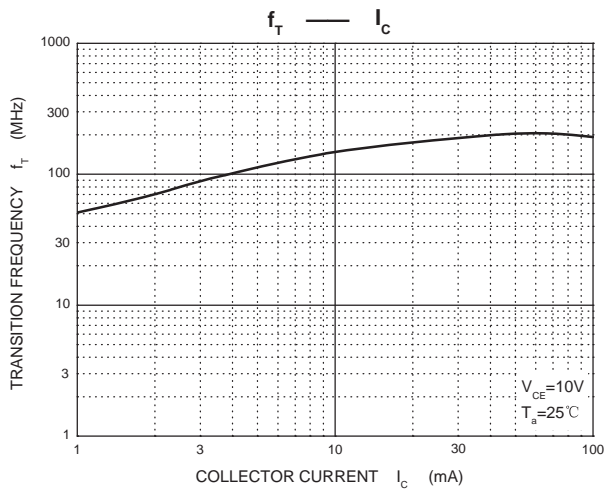

## TO-92 Package Outline Dimensions

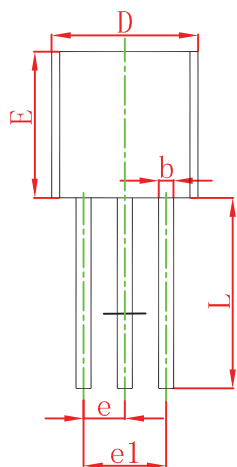
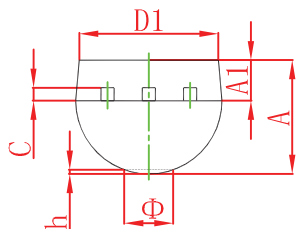

| Symbol | Dimensions In Millimeters |        | Dimensions In Inches |       |
|--------|---------------------------|--------|----------------------|-------|
|        | Min                       | Max    | Min                  | Max   |
| A      | 3.300                     | 3.700  | 0.130                | 0.146 |
| A1     | 1.100                     | 1.400  | 0.043                | 0.055 |
| b      | 0.380                     | 0.550  | 0.015                | 0.022 |
| c      | 0.360                     | 0.510  | 0.014                | 0.020 |
| D      | 4.300                     | 4.700  | 0.169                | 0.185 |
| D1     | 3.430                     |        | 0.135                |       |
| E      | 4.300                     | 4.700  | 0.169                | 0.185 |
| e      | 1.270 TYP                 |        | 0.050 TYP            |       |
| e1     | 2.440                     | 2.640  | 0.096                | 0.104 |
| L      | 14.100                    | 14.500 | 0.555                | 0.571 |
| Φ      |                           | 1.600  |                      | 0.063 |
| h      | 0.000                     | 0.380  | 0.000                | 0.015 |

## TO-92 Suggested Pad Layout

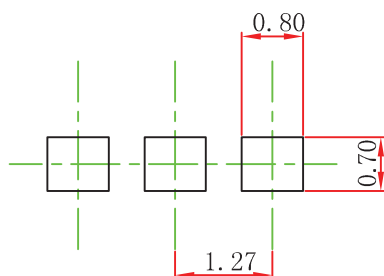

**Note:**

1. Controlling dimension: in millimeters.
2. General tolerance:  $\pm 0.05\text{mm}$ .
3. The pad layout is for reference purposes only.

## TO-92 Tape and Reel

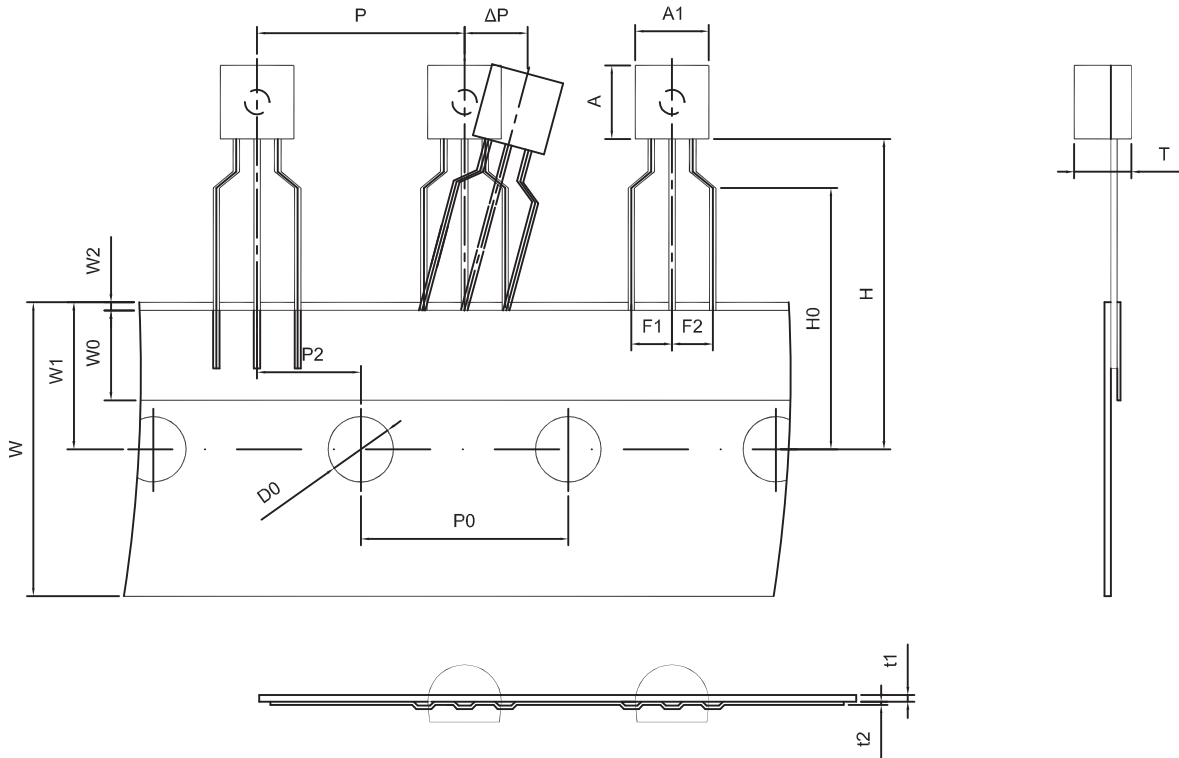

Dimensions are in millimeter

| A1  | A   | T        | P    | P0   | P2   | F1  | F2  | W          |
|-----|-----|----------|------|------|------|-----|-----|------------|
| 4.5 | 4.5 | 3.5      | 12.7 | 12.7 | 6.35 | 2.5 | 2.5 | 18.0       |
| W0  | W1  | W2       | H    | H0   | D0   | t1  | t2  | $\Delta P$ |
| 6.0 | 9.0 | 1.0 MAX. | 19.0 | 16.0 | 4.0  | 0.4 | 0.2 | 0          |

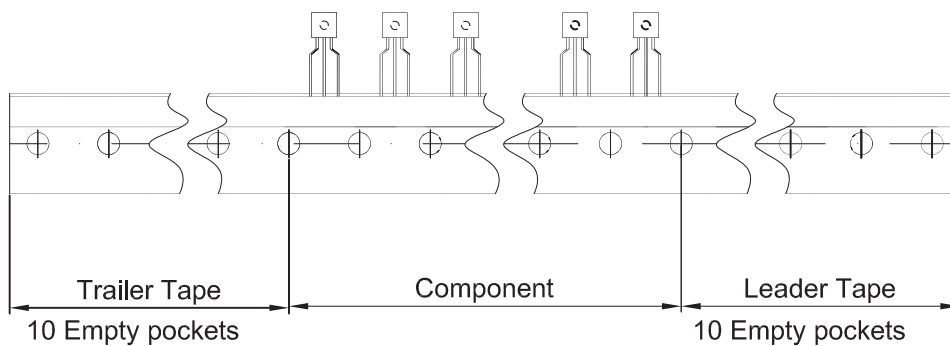

| Package | Box      | Box Size(mm) | Carton     | Carton Size(mm) |
|---------|----------|--------------|------------|-----------------|
| TO-92   | 2000 pcs | 333×162×43   | 20,000 pcs | 350×340×250     |