

Description

The LM393 consists of two independent voltage comparators. These were designed specifically to operate from a single power supply over a wide range of voltages. Operation from split power supplies is also possible and the low power supply current drain is independent of the magnitude of the power supply voltage. The outputs can be connected to other open-collector outputs to achieve wired-AND relationships.

Features

- Wide supply voltage range
- Low supply current drain independent of supply voltage. Low input biasing current
- Low input offset current
- Low input offset voltage
- Input common-mode voltage range includes GND
- Differential input voltage range equal to the power supply voltage
- Low output saturation voltage
- Output voltage compatible with TTL, MOS and CMOS logic

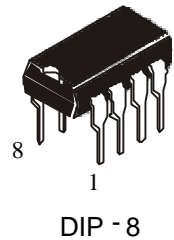

Package

Internal Block Diagram

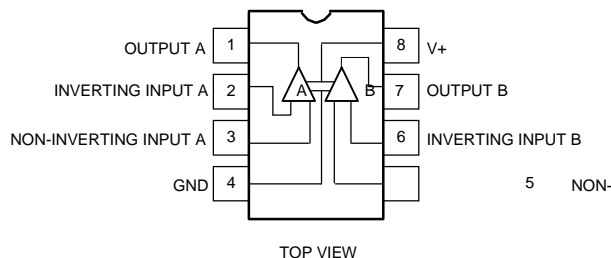

Electrical Characteristics

at specified free-air temperature, $V_{CC} = 5\text{ V}$ (unless otherwise noted)

Symbol	Parameter	Test conditions*		LM393			Units	
				Min	Typ	Max		
V_{IO}	Input offset voltage	$V_{CC} = 5\text{ V to }30\text{ V},$ $V_{IC} = V_{ICR\text{ min}},$ $V_{O}=1.4\text{ V}$	25 °C		2	5	mV	
			Full range			9		
I_{IO}	Input offset current	$V_{O}=1.4\text{ V}$	25 °C		5	50	nA	
			Full range			150		
I_{IB}	Input bias current	$V_{O}=1.4\text{ V}$	25 °C		-25	-250	nA	
			Full range			-400		
V_{ICR}	Common-mode input voltage range**		25 °C	0 to $V_{CC}-1.5$			V	
			Full range	0 to $V_{CC} - 2$				
A_{VD}	Large-signal differential voltage amplification	$V_{CC} = 15\text{ V},$ $V_{O}=1.4\text{ V to }11.4\text{ V},$ $R_L \geq 15\text{ k}\Omega$ to V_{CC}	25 °C	50	200		V/mV	
I_{OH}	High-level output current	$V_{OH}=5\text{ V}, V_{ID}=1\text{ V},$	25 °C		0.1	50	nA	
		$V_{OH}= 30\text{ V}, V_{ID}=1\text{ V}$	Full range			1	μA	
V_{OL}	Low-level output voltage	$I_{OL} = 4\text{ mA}, V_{ID}=-1\text{ V}$	25 °C		150	400	mV	
			Full range			700		
I_{OL}	Low-level output current	$V_{OL}= 1.5\text{ V}, V_{ID}=-1\text{ V}$	25 °C	6			mA	
I_{CC}	Supply current	$R_L = \infty$	$V_{CC} = 5\text{ V}$	25 °C		0.8	1	mA
			$V_{CC} = 30\text{ V}$	Full range			2.5	

* Full range (MIN to MAX), for the LM393 is 0 °C to 70 °C. All characteristics are measured with zero common-mode input voltage unless otherwise specified.

** The voltage at either input or common-mode should not be allowed to go negative by more than 0.3V. The upper end of the common-mode voltage range is $V_{CC} - 1.5\text{ V}$, but either or both inputs can go to 30V without damage.

Switching Characteristics

$V_{CC}=5\text{ V}, T_A=25\text{ °C}$

Parameter	Test conditions		Min	Typ	Max	Units
Response time	R_L connected to 5V through 5.1 k Ω , $C_L=15\text{ pF}$ * (See Note 1)	100-mV input step with 5-mV overdrive		1.3		μs
		TTL-level input step		0.3		

* C_L includes probe and jig capacitance.

Note 1: The response time specified is the interval between the input step function and the instant when the output crosses 1.4V.

Typical Applications Circuit

Driving TTL

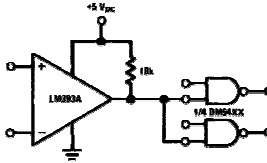

Driving CMOS

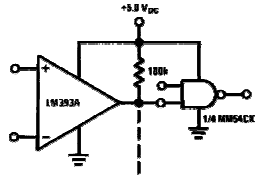

Basic Comparator

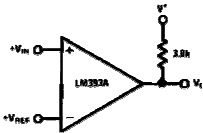

Squarewave Oscillator

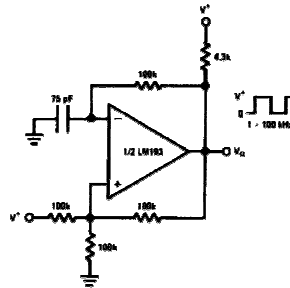

Pulse Generator

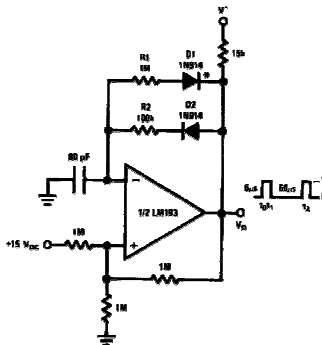

Crystal Controlled Oscillator

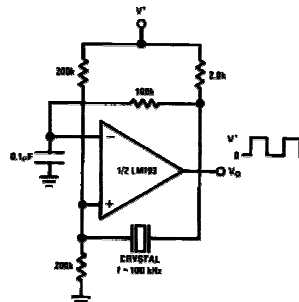

Ordering Information

ORDERING NUMBER	PACKAGE	MARKING
LM393	DIP - 8 / SOP - 8	LM393

Address : 北京市海淀区永定路 88 号长银大厦 6A06--6A07

Rm 6A07,Changyin Office Building ,No.88,Yong Ding Road,Hai Dian District ,Beijing

Postalcode:100039

Tel: 86-010-58895780 / 81 / 82 / 83 / 84 Fax : 010-58895793

[Http://www.estek.com.cn](http://www.estek.com.cn)

Email:sales@estek.com.cn

REV No:01-060820